

**This product may be purchased from Connevens Limited secure online store  
at [www.DeafEquipment.co.uk](http://www.DeafEquipment.co.uk)**



**DeafEquipment.co.uk**

Solutions to improve the quality of life



# Telephone Extension Booster

## Installation Instructions



### Introduction.

This telephone extension booster increases the power of the exchange ringing, allowing you to connect more products to your line. The Extension Booster can be used with all telephone products, including answer machines, fax machines and cordless telephones.

### A few technical details...

**To understand how to use the extension booster, a simple explanation of how the exchange rings may be helpful.**

On all modern telephone equipment you will find the word REN written somewhere on the product, usually underneath. REN means Ringer Equivalence Number, and is an indication of how much power the product takes from the exchange when it rings. Next to the word REN will be a number in the range 0 to 4. Most simple telephones have a REN of 1, and will be marked REN 1.

The exchange can only ring the products connected to your line if their total REN is 4 or less. If you add the REN numbers of all the products connected to your line and the number is 4 or less, then the exchange should be able to ring them without difficulty. If the number exceeds 4, you may need the extension booster to ensure they ring properly.

**The extension booster is capable of ringing products connected to it up to a total REN of 8. Depending where in your wiring system you connect the extension booster, you will be able to use a combination of exchange ringing and extension booster ringing to connect products to your line up to a total REN of 11.**

There are two important points to remember when using the extension booster. Firstly, the extension booster itself has a REN of 1. Secondly, if you connect a telephone to the socket on the side of the extension booster this telephone is powered from the exchange ringing not from the extension booster ringing. This telephone will still ring even if there is a mains failure. This product will not operate with ADSL, ISDN or Broadband.

### Understanding your telephone wiring

Check which type of master socket is fitted. The master socket is usually the first socket connected to the exchange line coming into the building. The options are:

This type of master socket is called the NTE 5. It is fitted on all new BT installations. By undoing the 2 screws you can unplug the front lower half to enable you to connect extension sockets by hard-wiring.

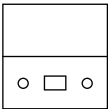

This is the old type of master socket which looks similar to an extension socket. It is normally the first socket connected to the exchange line when it enters the building. You are only permitted to connect extension sockets by plugging into this master socket.

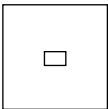

This type of connector indicates an older hard-wired installation. Please call 0800 800150 so that a BT engineer can fit a new NTE 5 master socket to enable you to connect your extension booster. This is a chargeable service.

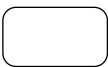

Now check your telephone wiring, it should be similar to one of the following diagrams:

### Master socket NTE 5 with hard-wired extension sockets:

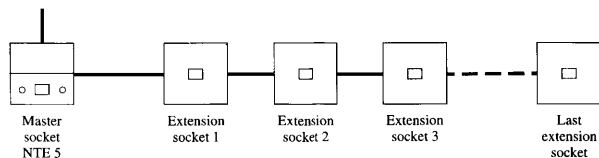

### Old type master socket with plug-in extension sockets:

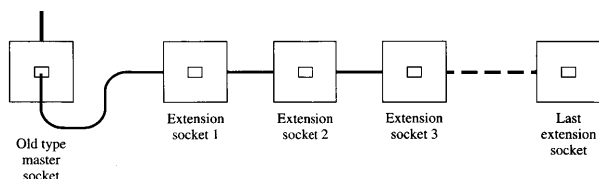

### Old type master socket with hard-wired extension sockets:

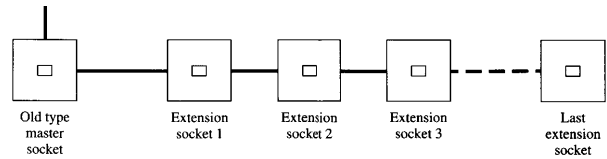

**Note:** You are not permitted to change the hard-wiring in this type of installation. You can ask your telephone service provider to change the wiring for you or you can connect new extension sockets to the extension booster and plug the extension booster into any of the existing sockets.

### Planning your new wiring

Having worked out how your telephones are wired, you can now decide where in the wiring system to install your extension booster. The extension booster can be installed anywhere in the system if you remember the following points:

- Only the wiring connected to the extension booster output carries the boosted ringing signal, the total REN of the equipment connected to this wiring must not exceed 8.
- The ringing for all other wiring is direct from the exchange, the total REN of the equipment connected to this wiring must not exceed 4. The Extension Booster is REN 1, leaving REN 3 spare for other equipment.
- The socket on the extension booster is connected to exchange ringing not to boosted ringing. Any equipment plugged into this socket rings as equipment rung by the exchange.
- The extension booster must be plugged into a master socket or an extension socket connected to exchange ringing.

Connection Options	Master Socket NTE 5	Old Master Socket
Plug the extension booster into any socket on the existing wiring and install new hard-wired extension sockets from the extension booster.	✓	✓
Disconnect the hard-wired extension sockets from the master socket and reconnect from the extension booster.	✓	✗
Unplug the plug-in extension sockets from the master socket and connect the extension booster between the master socket and the first extension socket. Use only hard-wiring between the extension booster and extension sockets.	✓	✓

### Wiring example

The following diagram shows a typical system with the extension booster connected to master socket NTE 5:

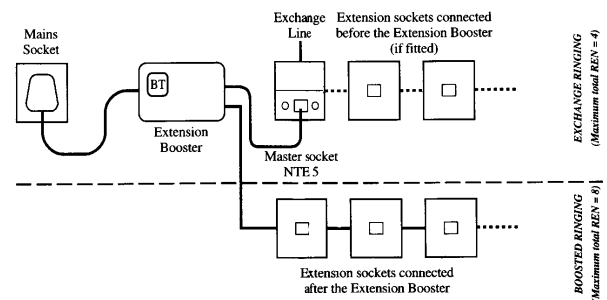

It does not matter how many sockets are connected either before or after the extension booster. It is only the REN of the equipment connected to the sockets that matters. Sockets with no equipment connected can be ignored when calculating the total REN.

# Telephone Extension Booster

## Installation Instructions



### Fitting & connecting your Extension Booster

**Do not plug in the mains or telephone plugs until all wiring has been completed**

#### 1. Location

Choose a suitable location near a mains socket and near to the master or extension socket you want to use.

#### 2. Fixing

- Mark two fixing positions on the wall using guide holes A & B on the template at the bottom of these instructions.
- Drill two holes to suit the plugs supplied. Insert the plugs until they are flush with the wall.
- Fit the two screws into the plugs leaving a small gap (approx. 3mm) between the wall and the underside of the screw head.

#### 3. Wiring

- Remove the single screw from the terminal cover in the bottom left corner at the rear of the Extension Booster to remove the cover.
- Using 4 or 6 wire telephone cable, connect the terminal block in the Extension Booster to the terminals in the next extension socket. Further extensions sockets can then be run from this socket. The following wire colours are normally used in BT installations:

Terminal Block	Wire Colour
2	Blue with white stripes
3	Orange with white stripes
4	White with orange stripes
5	White with blue stripes

If your existing wiring colours do not match these colours check which wire colour is connected to each terminal number in your extension sockets then connect the same coloured wires to same terminal numbers in your Extension Booster. For all telecommunications wiring you are recommended to follow the OfTel wiring code. Copies are available by calling OfTel on 0207 6348700

- Secure the cable in the Extension Booster using the cable tie near the terminal block. You are recommended to leave some spare cable in the terminal block compartment to make it easy to remove the Extension Booster in the future.
- Replace the terminal cover and tighten the screw.

#### 4. Mounting and connecting up

- Hang the Extension Booster on the screws on the wall. The small gap between the screw head and the wall may need to be adjusted for the Extension Booster to be securely mounted.
- Insert the Extension Booster telephone plug into the master socket or an extension socket connected to it.
- Plug a telephone or Extension Tonecaller into the socket on the Extension Booster so you can hear calls if there is a mains failure.
- Insert the 13A plug on the Extension Booster into a mains socket and switch on.
- Give someone a ring and ask them to call you back. Replace your handset. When the ringing starts check that all the telephone equipment connected to the exchange line and Extension Booster is ringing correctly.

**If you need to remove the Extension Booster or change the wiring to the extension sockets, you must switch off the mains socket and remove the 13A plug, also remove the telephone plug from the master or extension socket, before removing the terminal cover. Only use a 3A fuse in the mains plug. Please do not open up the REN Booster as their are no user serviceable parts.**

**IMPORTANT:** The wires in this mains lead are coloured in accordance with the following code:

**Blue: Neutral Brown: Live**

**If you remove the moulded-on plug to shorten the mains lead the new plug must be wired as follows: the blue wire must be connected to the terminal which is marked with the letter N or coloured blue or black. The brown wire must be connected to the terminal which is marked with the letter L or coloured brown or red. Neither wire should be connected to the earth terminal. Dispose of the moulded-on plug safely.**

### Operating Instructions

Some factors may however, some factors may affect the operation of the Extension Booster, these are:

**Mains Failure:** In the event of mains failure any telephone equipment connected after the Extension Booster will not ring, but calls can still be made and received. The telephone connected to the socket on the side of the Extension Booster and telephones connected before the Extension Booster will ring whether the mains is on or off. The telephone connected to the socket on the side of the Extension Booster and telephones connected before the Extension Booster may suffer 'bell tinkle' when dialling in pulse/LD mode on telephones connected after the Extension Booster during mains failure. To avoid the possibility of 'bell tinkle' you are advised to dial in tone/MF mode.

**Switchboards:** The Extension Booster can be connected to a direct exchange line or an extension port of an approved switchboard. Generally, it can be connected to any extension port where a simple telephone can be used. It is not suitable for connection to BT Ambassador or Escort switchboards.

**Compatibility:** In the unlikely event of any equipment not functioning correctly when connected after the Extension Booster try connecting the equipment to the socket on the Extension Booster or to an extension socket connected before the Extension Booster.

### Product safety

- This product is not suitable for outdoor use.
- Do not install near sinks, showers, baths, cookers, swimming pools, etc., or in a damp environment.
- The Extension Booster has been approved for boosting the incoming ringing signal. Any other use will invalidate the approval of the apparatus if, as a result, it then ceases to conform to the standards against which approval was granted. In order to respond to incoming calls, a telephone or other answering equipment must be connected to the line in addition to the Extension Booster.

### Statutory information

Additional socket on side of Extension Booster - Telecommunication Network Voltages (TNV) circuits.

Interconnection circuits should be such that the equipment continues to comply with the requirements of 4.2 of EN 41003 for TNV circuits after making connections between circuits.

